

# Rectangle Hanging Banner

## ACCESSORIES



- A: Straight Bar: Right Side+ Left Side
- B: Serpentine Bar
- C: Eyebolt
- D: Short Screw
- E: Curved Side Support
- F: Wire rope + Extra / Replacement Pieces

Product Size	Straight Bar A	Serpentine Bar B	Eyebolt C	Short Screw D	Curved Side Support E	Wire rope F
10'W x 36'H	20	4	4	16	6	1
10'W x 48'H	20	4	4	16	6	1
12'W x 36'H	20	4	4	16	6	1
12'W x 48'H	20	4	4	16	6	1
14'W x 36'H	24	4	6	18	8	1
14'W x 48'H	24	4	6	18	8	1

## STEPS FOR ASSEMBLY

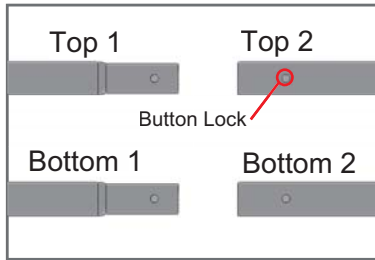

### Step 1

Join the Straight Bars (A) together to form a Square Frame. Repeat steps for another Square Frame.

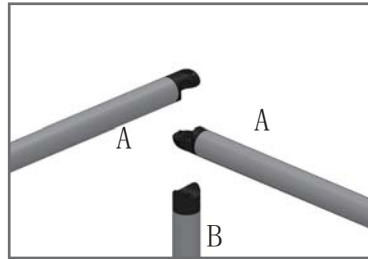

### Step 2

Pick up the sides for Bottom Square, align the end of each side as show.

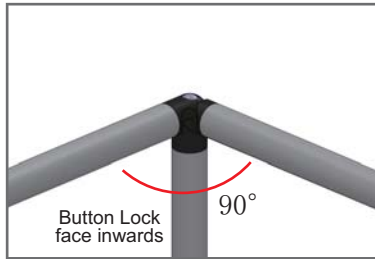

### Step 3

Make sure it is a 90 degree angle on each corner.

**Please Note:** Button locks should be facing downwards when assembling top frame, and upwards when assembling bottom frame.

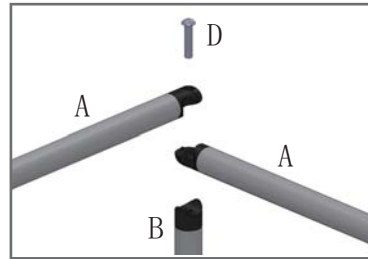

### Step 4

And then, use a short screws (D) to fix the Serpentine Bar (B), Repeat for each corner of bottom frame as image.

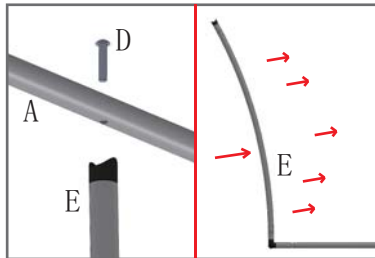

### Step 5

Align each Curved Side Support (E) with the holes in the center of each side, make sure the Curved Side Support (E) towards the center of square. Then, attach Short Screws (D) as image.

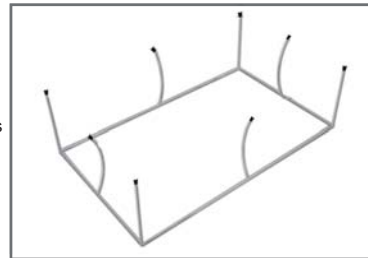

### Step 6

Place the assembled bottom frame on the floor.

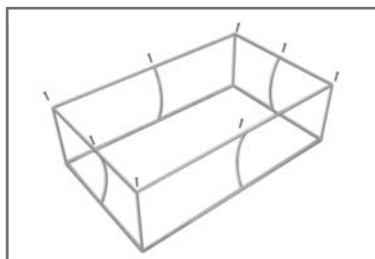

### Step 7

Attach the Top Square on the assembled frame, using the remaining Short Screws (D) to fix the Curved Side Support (E), Align the corners but do not attach.

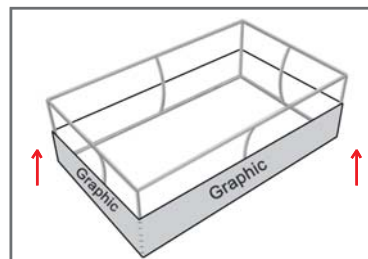

### Step 8

Unzip the Graphic all the way around, then push the blank back side of graphic under the bottom frame.

With the help of another person, position your graphic, ensure the graphic is facing right-side up. Then, raise the graphic up.

### Step 9

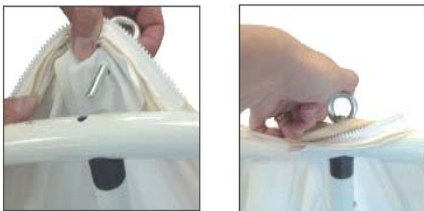

Find the reinforced hole in the Graphic that is nearest to the zipper ends. Feed an Eyebolt (C) into the top hole of Serpentine Bar (B), then hand tighten.

### Step 10

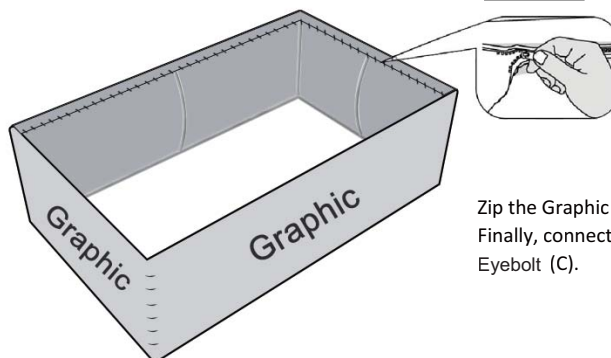

Zip the Graphic closed all the way around. Finally, connect the wire rope (F) to the loops of Eyebolt (C).

